

PRODUCT NAME: Kellan Low Back Stool



ITEM NUMBER: 178341 / 178342

DIMENSIONS OF ITEM ASSEMBLED: 21.75" x 17.5" X40" (ITEM :178341)

21.75" x 17.5" x 34" (ITEM :178342)

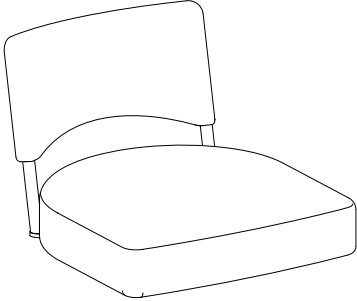
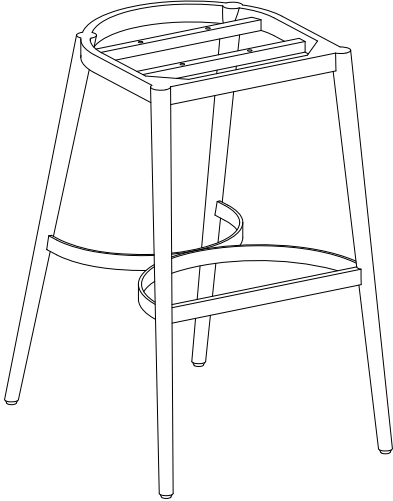

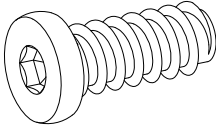
Ltr.	Qty.	Description.	Components
A	1	Seat	
B	1	Base	

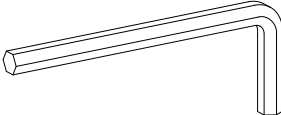
Ltr.	Qty.	Description.	Hardware Included
C	4	Allen Bolts	 Ø1/4"x1-1/4"
D	4	Lock Washer	
E	4	Flat Washer	
F	1	Allen Key	

STEP 1: Attach Seat (A) to Base (B) using Bolt (C), Spring Washer (D), Flat Washer (E) and Allen Key (F).

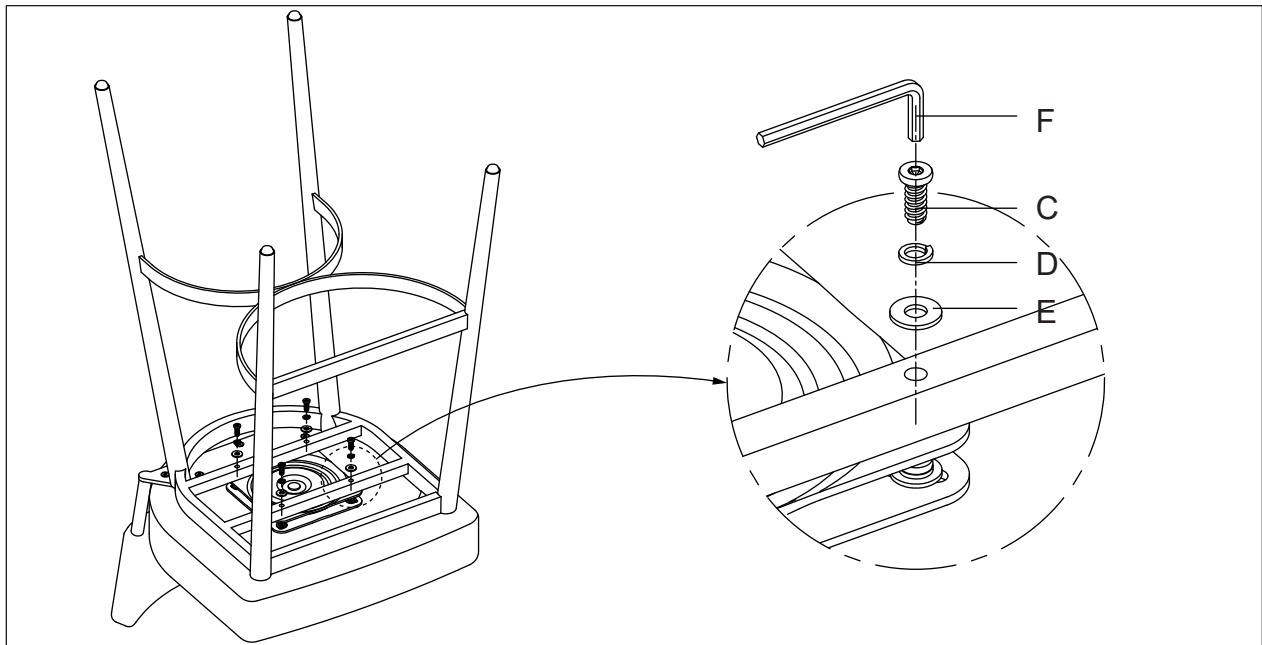

Cleaning & Care:

Wipe with damp cloth and mild detergent. Avoid the use of any abrasive cleaning agents as this may mar the surface. Always lift the unit when moving and avoid dragging to prevent loosening or damaging frame structure.